

FOAM FILLED DOUBLE FIRST BASES

Models SBB-303, SBB-282, SBB-302

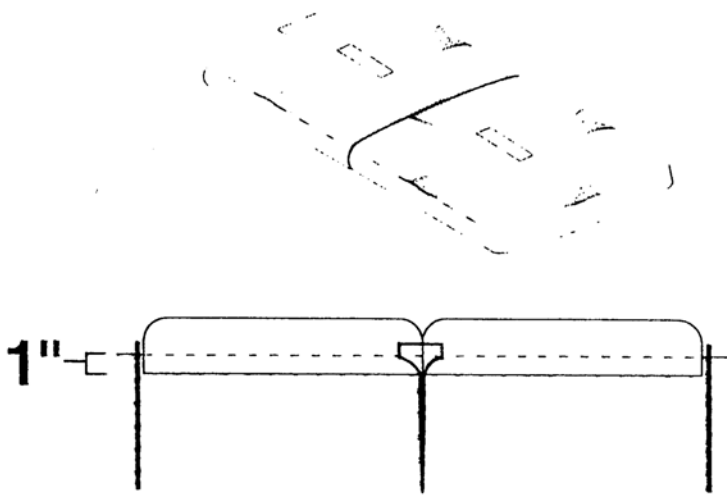

CAUTION: Installer should make sure base is one inch below playing surface.

SCHUTT ANCHOR BASES

Models SBB-ML, SBB-PS & SBB-SA

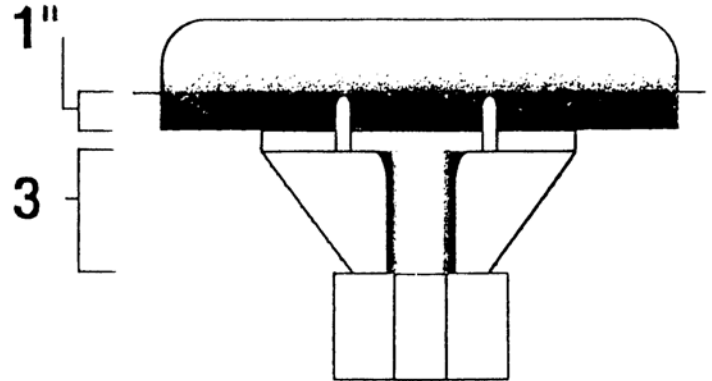

CAUTION: Installer should make sure base is one inch below playing surface.

SCHUTT ANCHOR STYLE HOME PLATE

Model SHP-AS

36542



CAUTION: Installer should make sure top of home plate is level with playing surface.

SCHUTT ANCHOR STYLE DOUBLE FIRST BASE

Model SBB-SFB

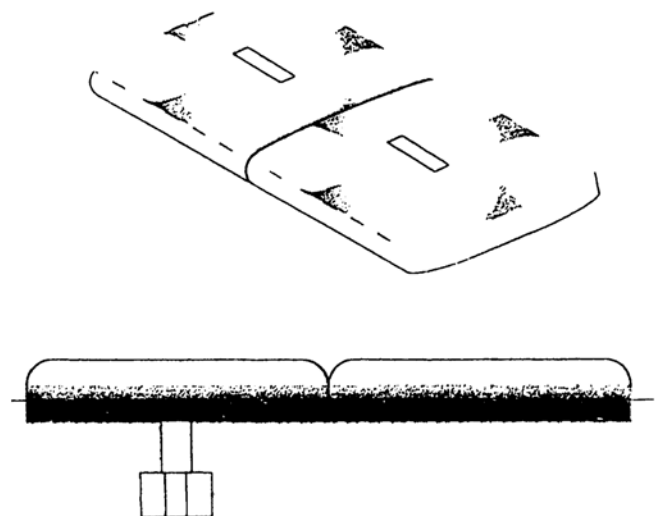

CAUTION: Installer should make sure base is one inch below playing surface.

ECONOMY HOME PLATE

Model SHP-EC

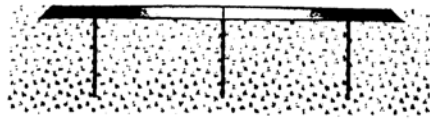

SPECIAL NOTE: When installing do not pound directly on the plate because it may cause damage. Place a 2-inch thick piece of wood over the plate and use a hammer to lightly pound on the block of wood.

CAUTION: Installer should make sure top of home plate is level with playing surface.

BURY STYLE PERMANENT INSTALLATION

Model SHP-BS

36540

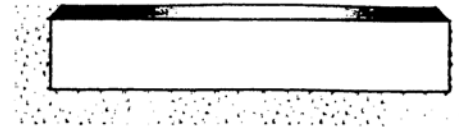

CAUTION: Installer should make sure top of home plate is level with playing surface.

ECONOMY PITCHER'S PLATES

Model SPR-EC & SPR-ECY

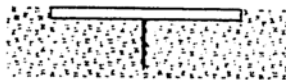
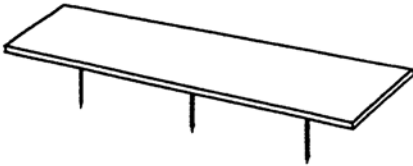

SPECIAL NOTE: When installing do not pound directly on the plate because it may cause damage. Place a 2-inch thick piece of wood over the plate and use a hammer to lightly pound on the block of wood.

CAUTION: Installer should make sure pitcher's plate is level with playing surface.

4-SIDED PITCHER'S PLATES

Model SPR-4SO & SPR-4SY

36572

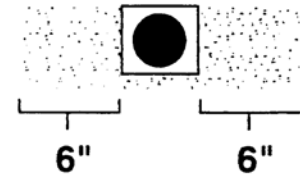
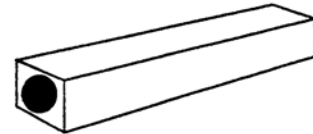

CAUTION: Installer should make sure pitcher's plate is level with playing surface.

STEP DOWN PITCHER'S PLATES

Model SPR-SD & SPR-SDY

36576

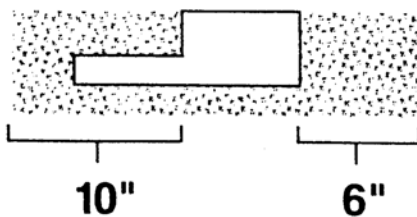
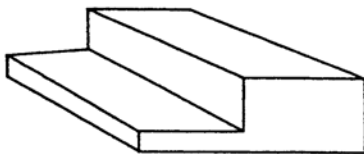

CAUTION: Installer should make sure pitcher's plate is level with playing surface.

FOAM FILLED BASES

Model SBB-153, SBB-153C, SBB-142, SBB-142C, SBB-152, SBB-152C

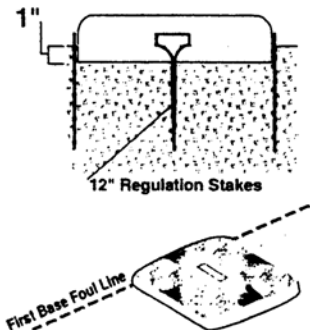

CAUTION: Installer should make sure base is one inch below playing surface. To avoid injury, do not use in ground anchors in combination with this product.